

E & D SPECIALTY STANDS INC.

2081 Franklin St.
P.O. Box 700,
North Collins, NY. 14111
P. 800-525-8515 F. 716-337-3436

ALUMINUM DIES



ALUMINUM PLANK (FP SERIES)

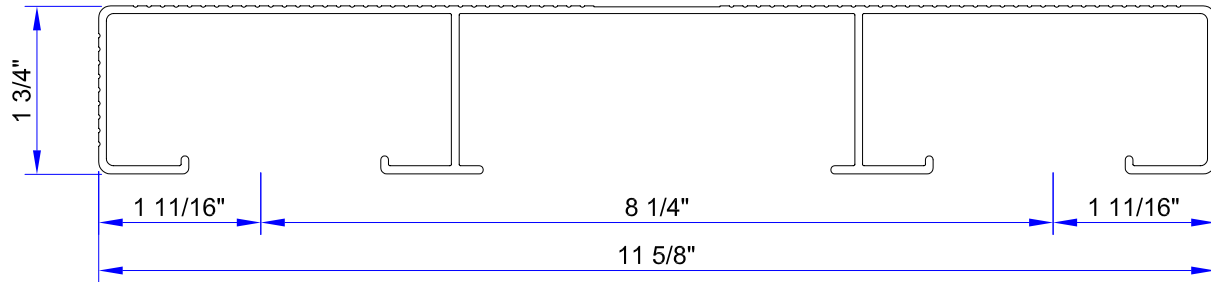

2 x 12 SC-DECK (ALCOA # 69963)

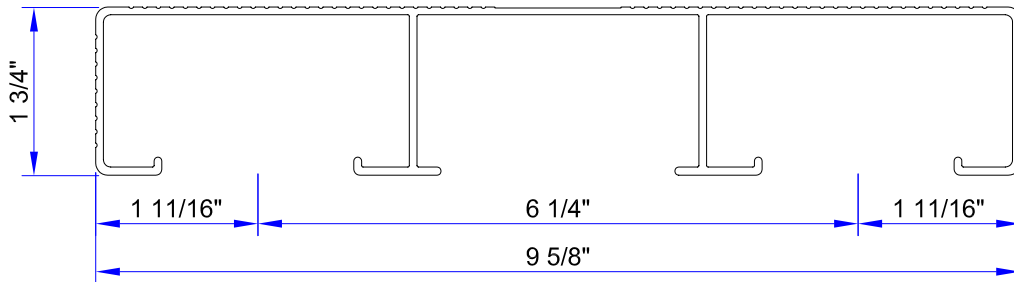

2 x 10 SC-DECK (ALCOA # 69959)

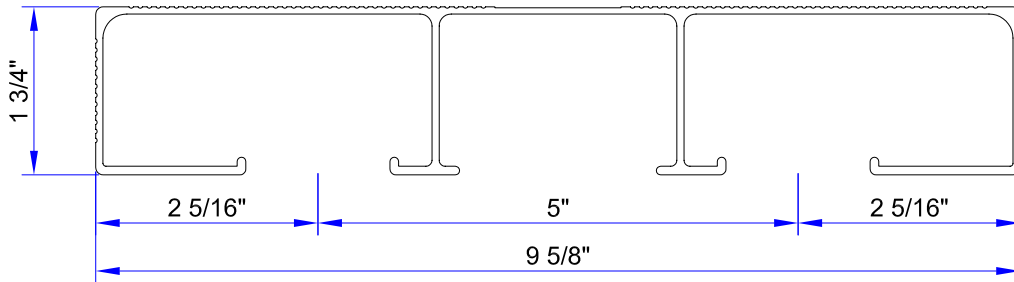

2 x 10 (ALCOA # 60772)

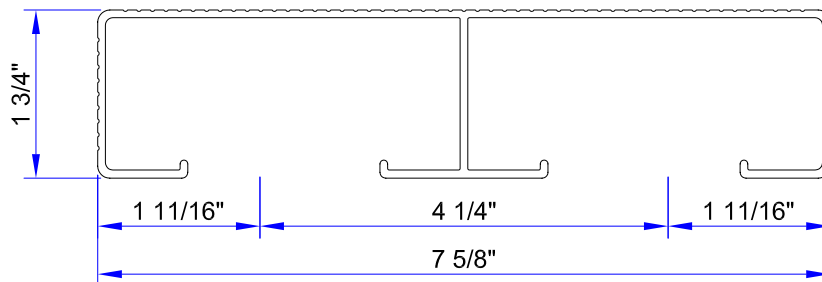

2 x 8 SC-DECK (ALCOA # 69962)

ALUMINUM PLANK (FP SERIES)

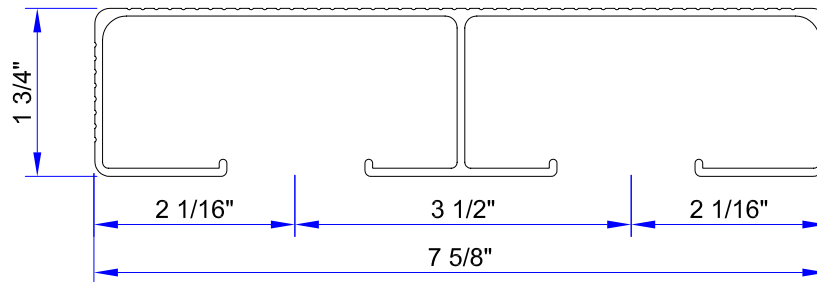

2 x 8 (ALCOA # 65482)

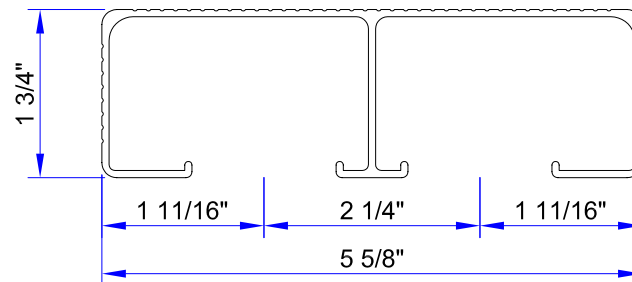

2 x 6 (ALCOA # 12214)

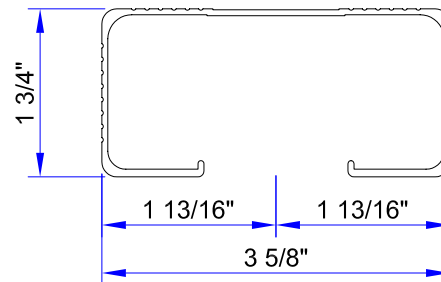

2 x 4 (ALCOA # 14993)

ALUMINUM RISERS (FP SERIES)

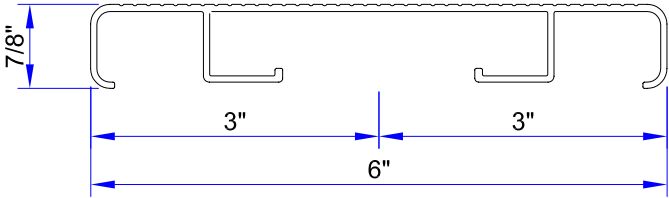

1 x 6 SC-RISER (ALCOA # 70003)

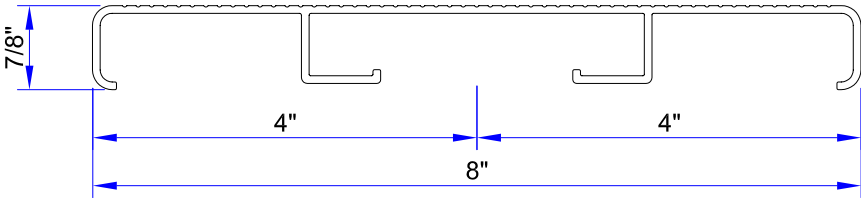

1 x 8 SC-RISER (ALCOA # 70001)

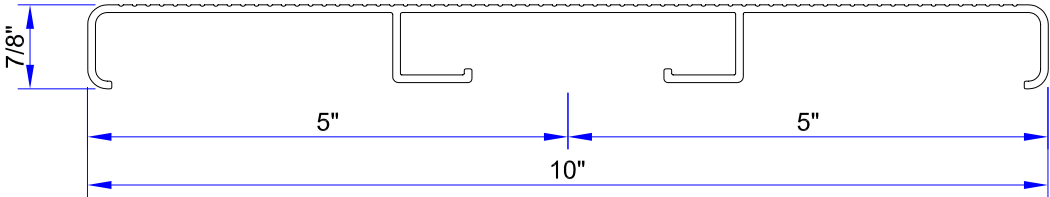

1 x 10 SC-RISER (ALCOA # 70004)

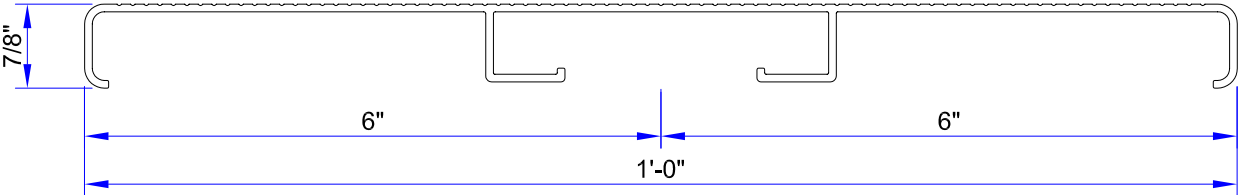

1 x 12 SC-RISER (ALCOA # 70002)

ALUMINUM PLANK (CI SERIES)

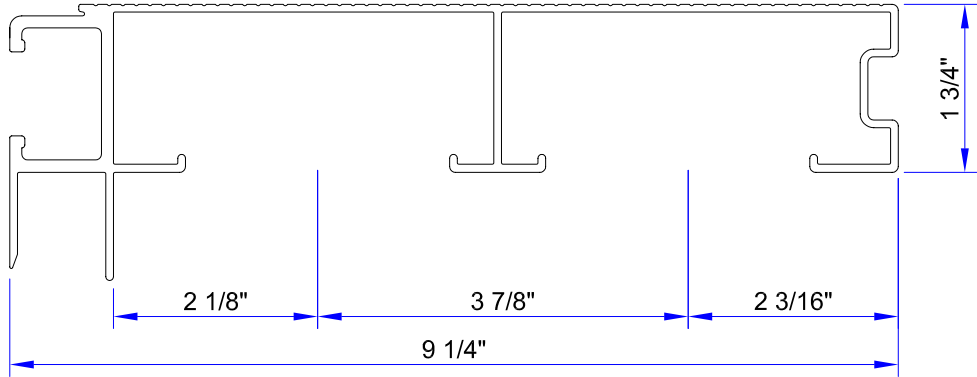

2 x 9 CI-NOSE (ALCOA # 69804)

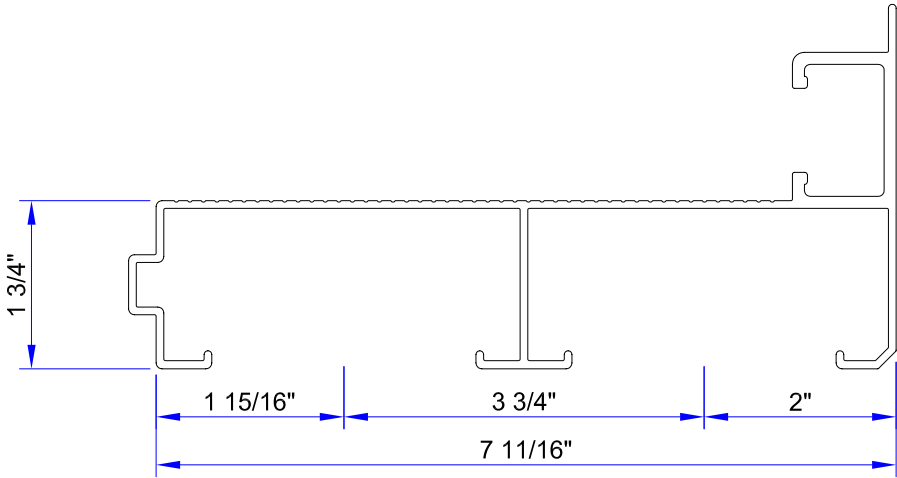

2 x 7 CI-HEEL (ALCOA # 69800)

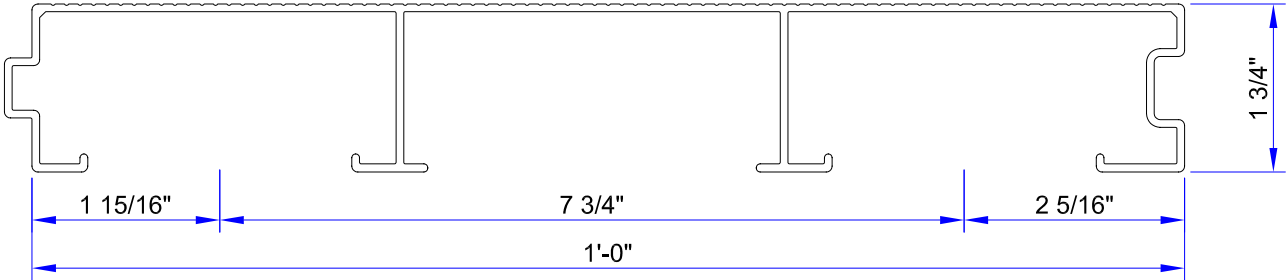

2 x 12 IL-DECK (ALCOA # 69960)

ALUMINUM PLANK (CI & WD SERIES)

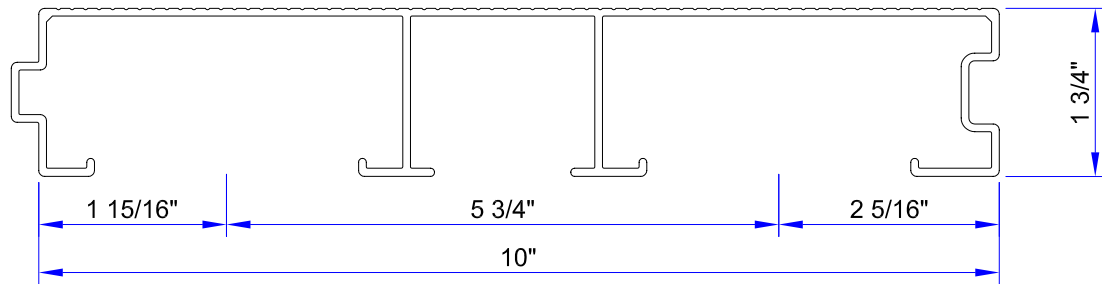

2 x 10 IL-DECK (ALCOA # 69802)

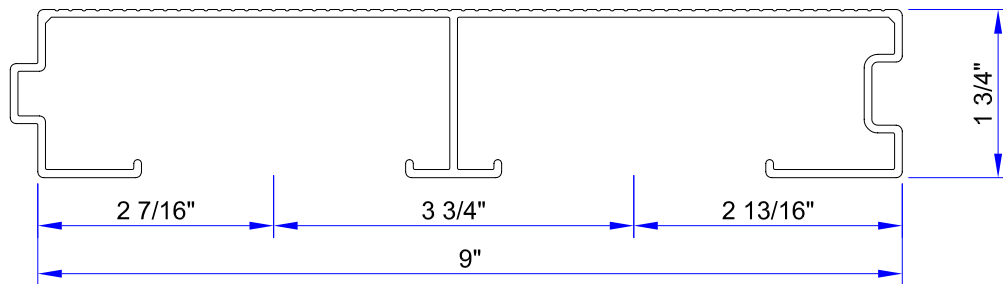

2 x 9 IL-DECK (ALCOA # 69964)

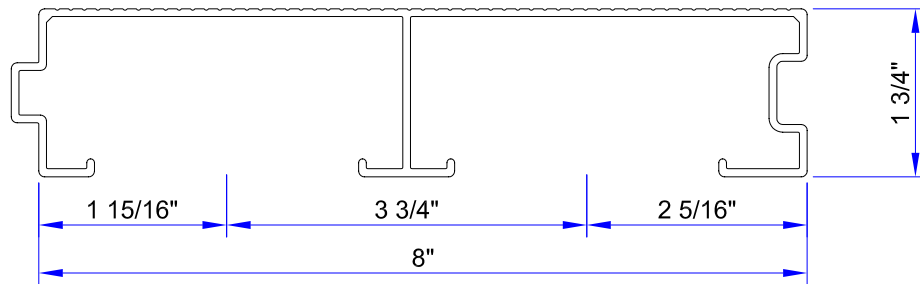

2 x 8 IL- DECK (ALCOA # 69803)

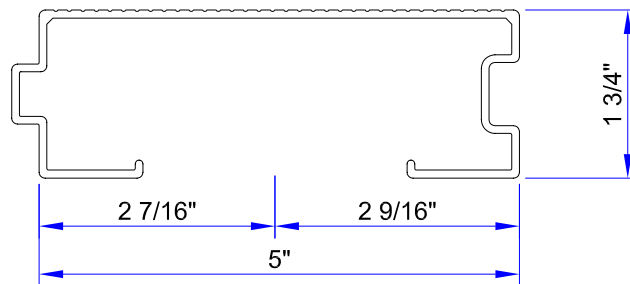

2 x 5 IL- DECK (ALCOA # 69965)

ALUMINUM RISERS (CI & GI SERIES)

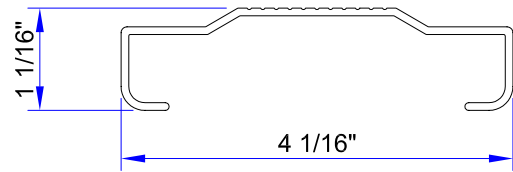

1 x 4 CI-RISER (ALCOA # 69973)

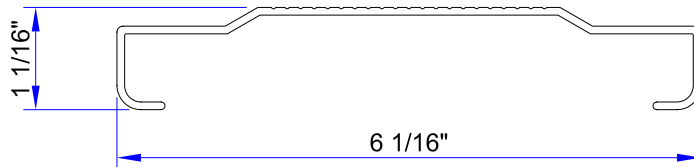

1 x 6 CI-RISER (ALCOA # 69974)

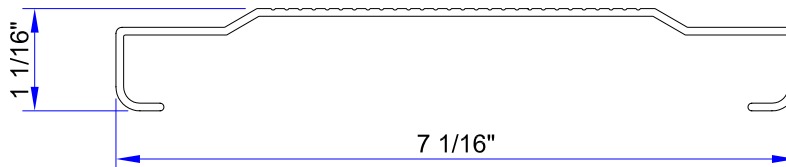

1 x 7 CI-RISER (ALCOA # ?????)

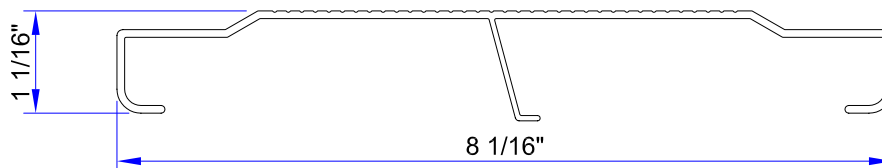

1 x 8 CI-RISER (ALCOA # 69850)

ALUMINUM RISERS (CI & GI SERIES)

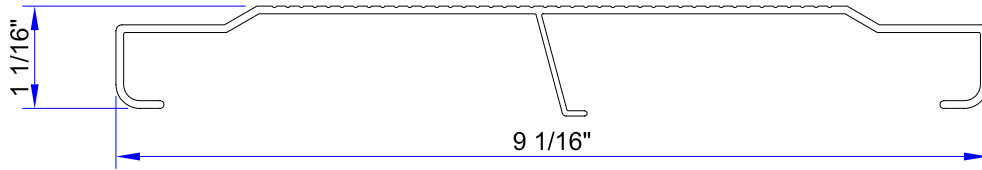

1 x 9 CI-RISER (ALCOA # 69987)

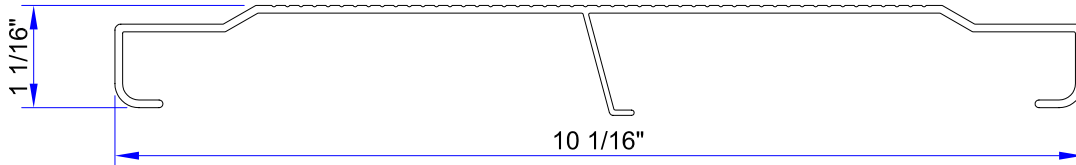

1 x 10 CI-RISER (ALCOA # 69988)

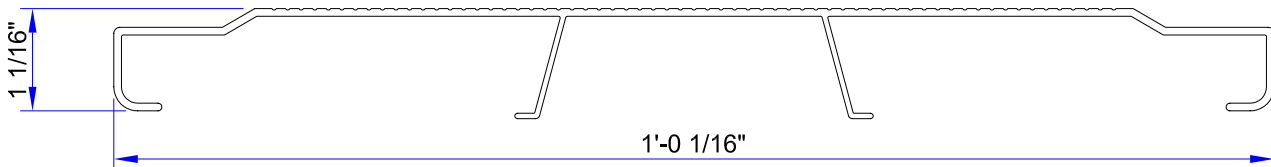

1 x 12 CI-RISER (ALCOA # ?????)

ALUMINUM PLANK (GI SERIES)

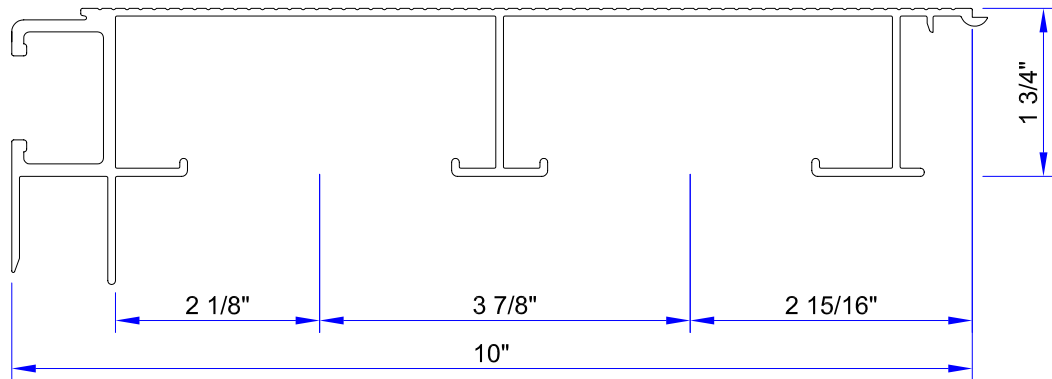

2 x 10 GI-NOSE (ALCOA # 69942)

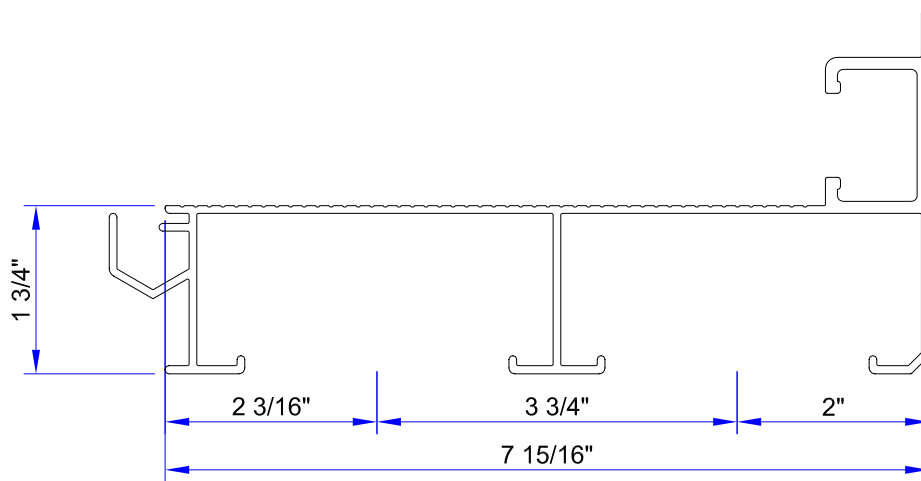

2 x 7 GI-HEEL (ALCOA # 69943)

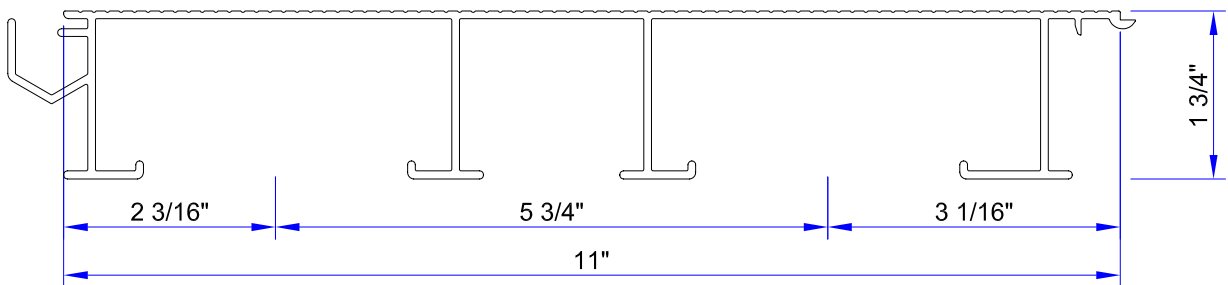

2 x 11 GI-DECK (ALCOA # 69946)

ALUMINUM PLANK (GI SERIES)

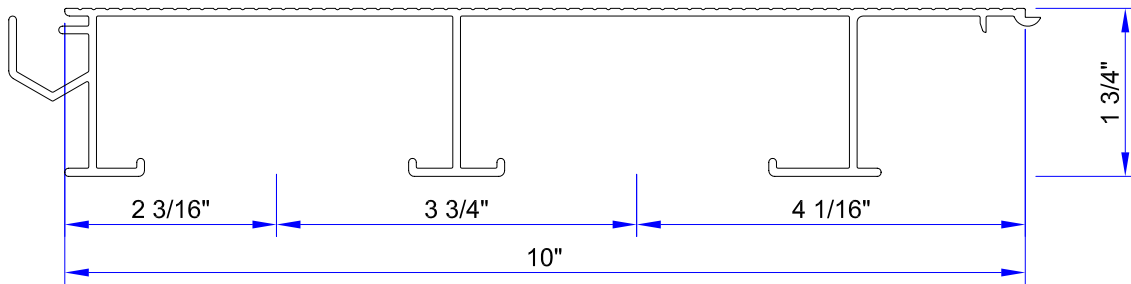

2 x 10 GI-DECK (ALCOA # 69970)

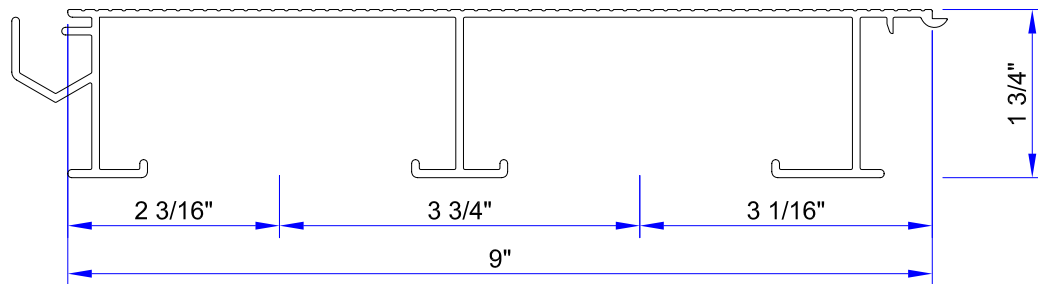

2 x 9 IL-DECK (ALCOA # 69945)

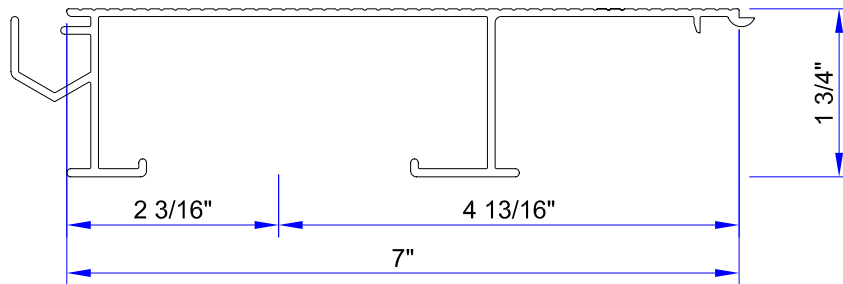

2 x 7 GI-DECK (ALCOA # 69944)

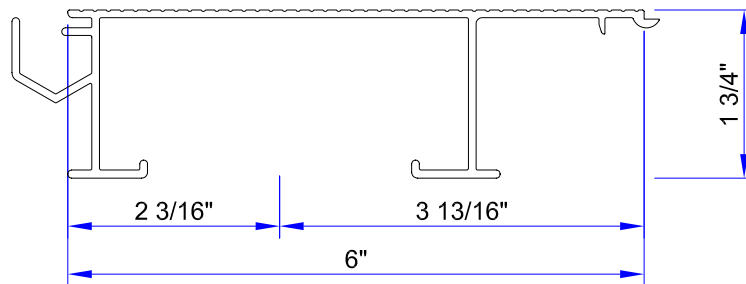

2 x 6 GI-DECK (ALCOA # 69969)

ALUMINUM PLANK (WD SERIES)

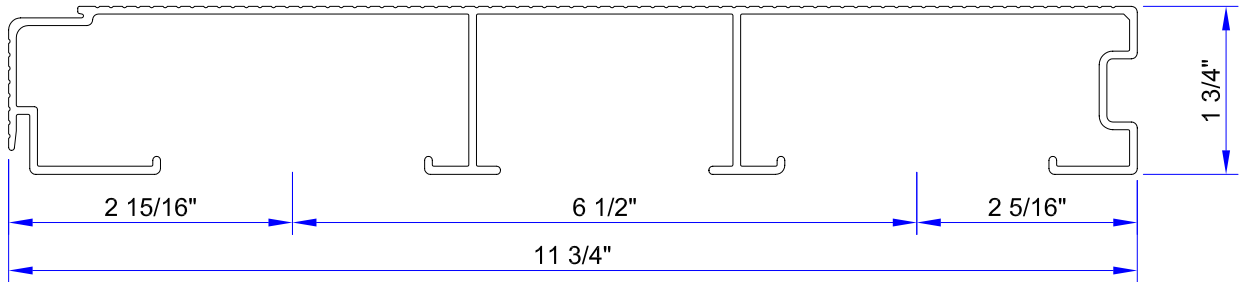

2 x 12 IL-NOSE (ALCOA # 69961)

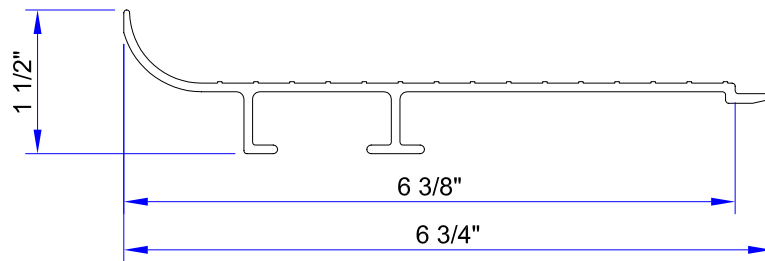

1 1/2 x 6 IL-RISER (ALCOA # 68195)

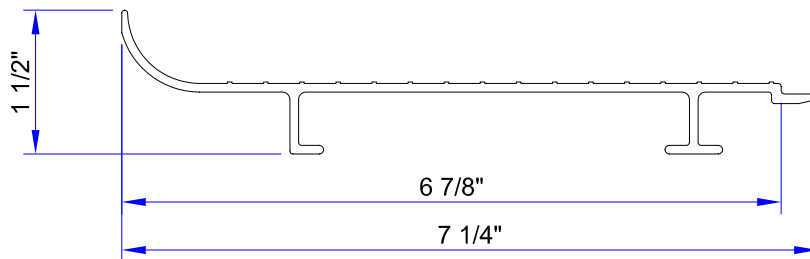

1 1/2 x 6 1/2 IL-RISER (ALCOA # 69637)

ALUMINUM RISERS (WD SERIES)

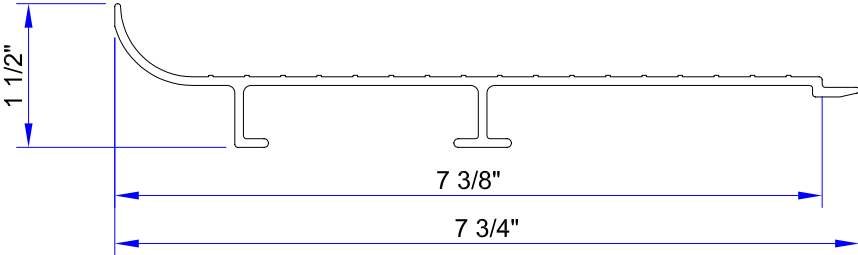

1 1/2 x 7 IL-RISER (ALCOA # 68492)

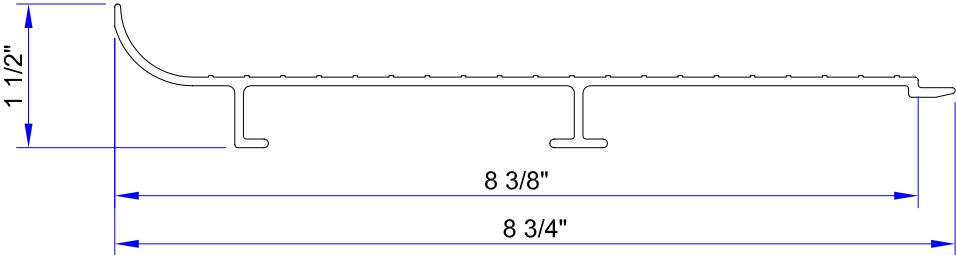

1 1/2 x 8 IL-RISER (ALCOA # 68194)

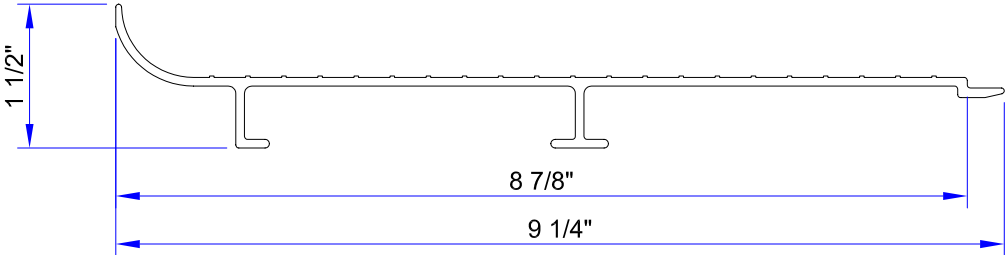

1 1/2 x 8 1/2 IL-RISER (ALCOA # 69704)

ALUMINUM RISERS (WD SERIES)

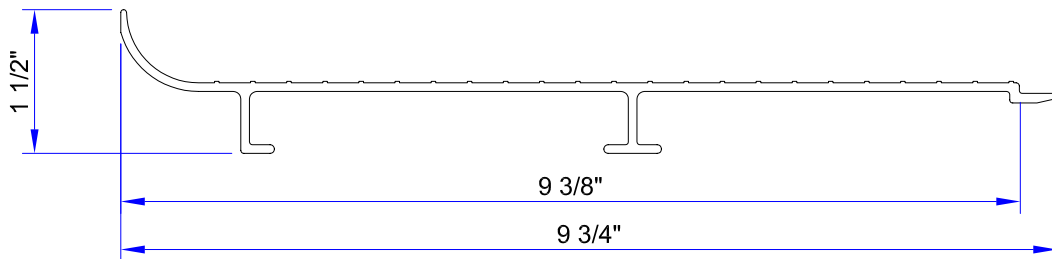

1 1/2 x 9 IL-RISER (ALCOA # 68395)

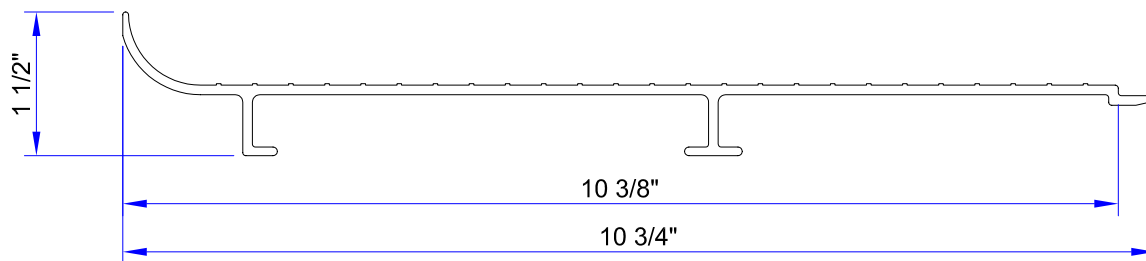

1 1/2 x 10 IL-RISER (ALCOA # 68105)

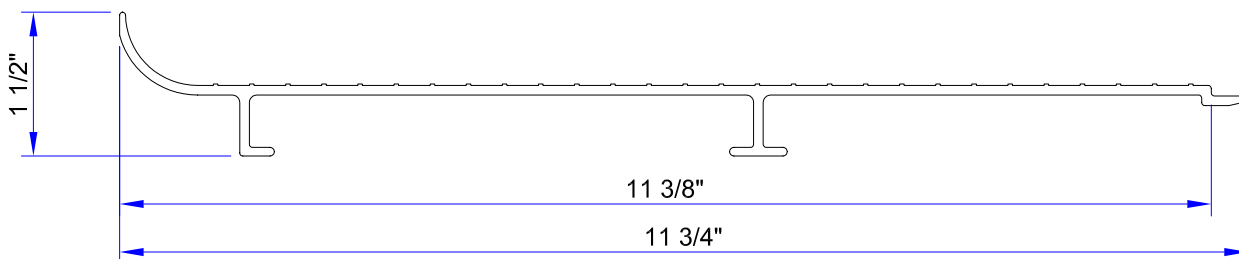

1 1/2 x 11 IL-RISER (ALCOA # 68106)

ALUMINUM NOSING & CLOSURES

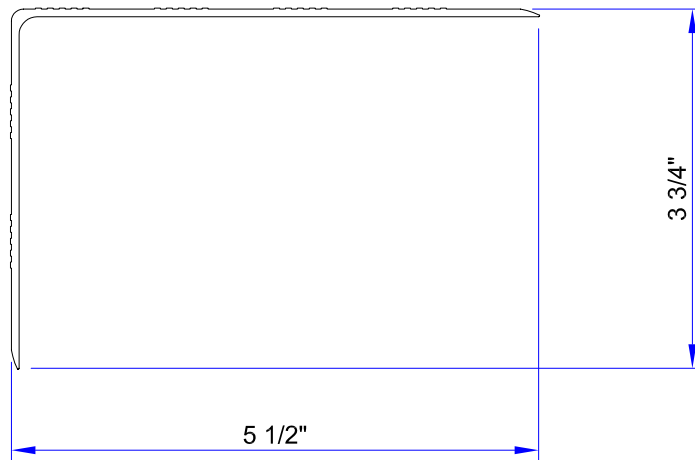

CLOSURE FOR SEMI-CLOSED DECK(ALCOA # 65987)

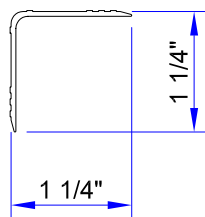

1 1/4" COLORED NOSE
(ALCOA # 68566)

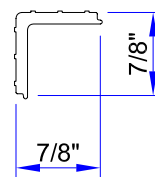

1" COLORED NOSE
(ALCOA # 68024)

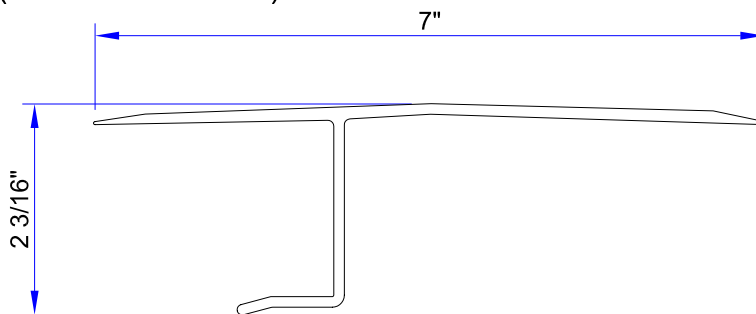

EXPANSION JOINT COVER (ALCOA # 66638)

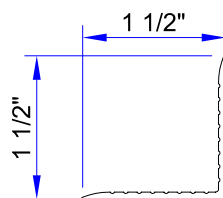

1 1/2" CLOSURE (ALCOA # 66782)

ALUMINUM CONTOURED SEATS

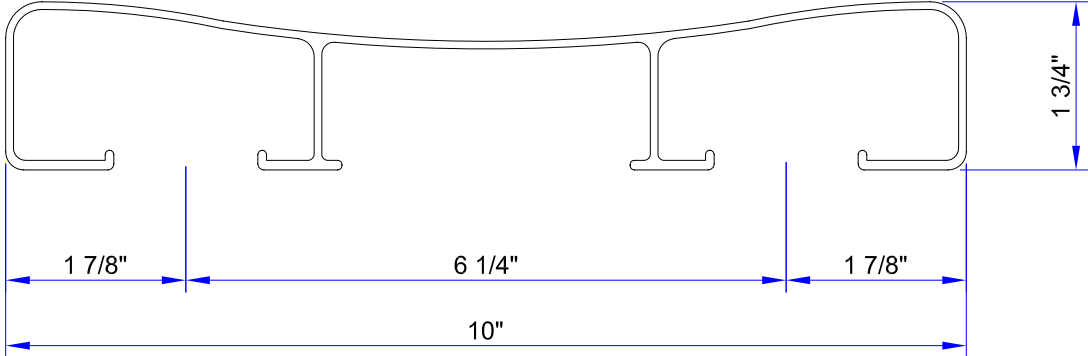

10" CONTOURED SEAT(ALCOA # 68754)

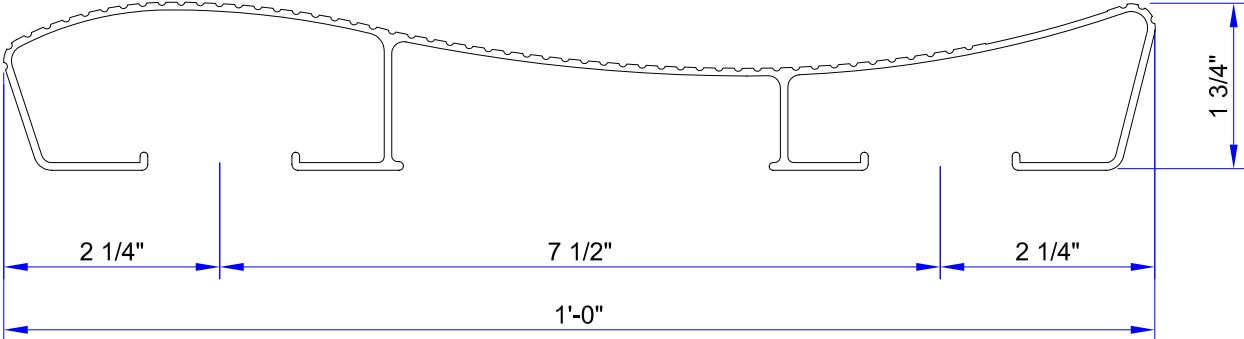

12" CONTOURED SEAT(ALCOA # 11965)

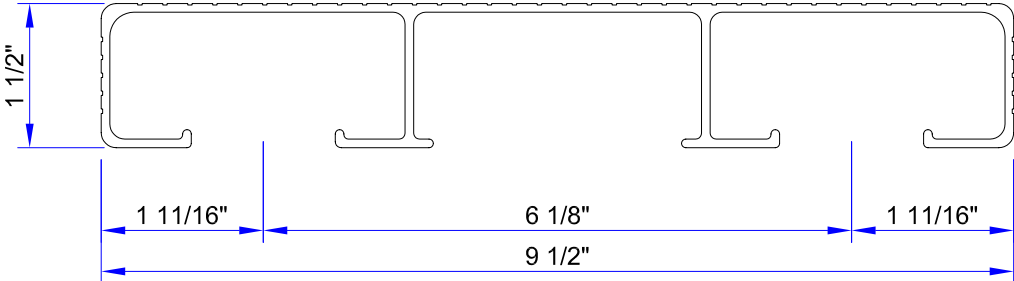

1 1/2 x 9 1/2 SEAT SUPPORT FOR PERMA CAP (ALCOA# 67817)

ALUMINUM BACK RESTS

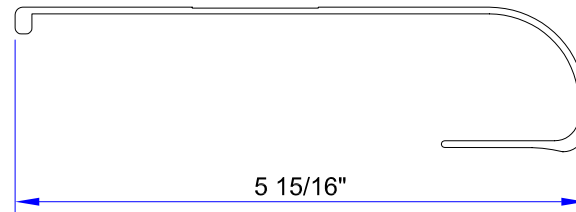

CONTOURED DISH BACK (ALCOA # 11161)

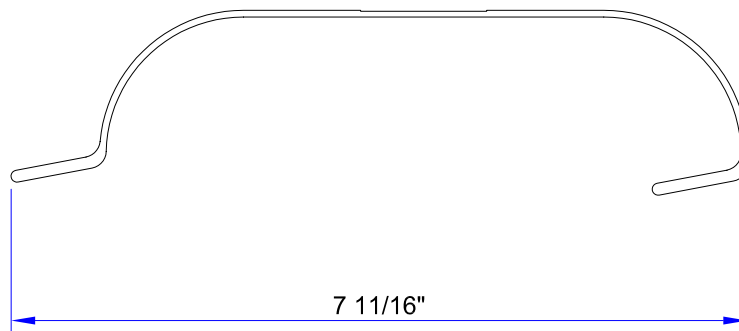

CONTOURED SEAT BACK (ALCOA # 11530)

ALUMINUM STAIR PLANKS

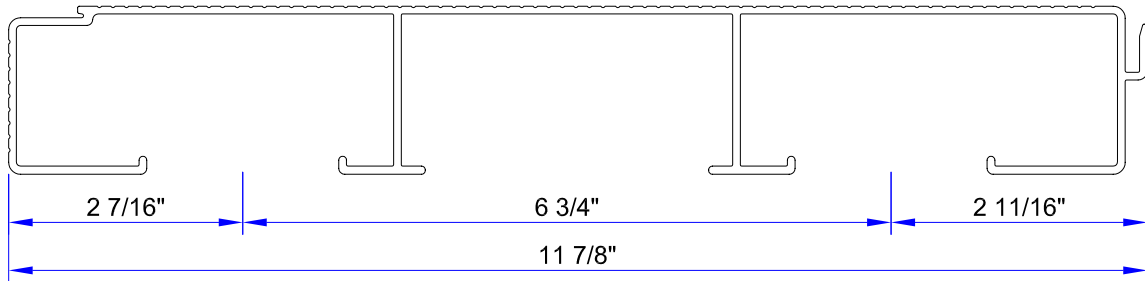

2 x 12 STEP BOARD (ALCOA # 69972)

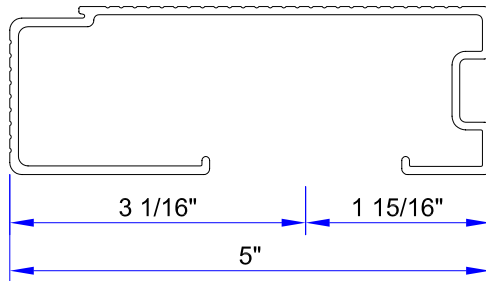

2 x 5 STEP NOSE (ALCOA # 70014)

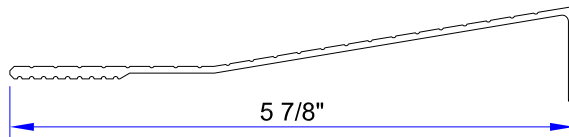

STAIR RISER (ALCOA # 69733)

ALUMINUM PLANK INSERTS

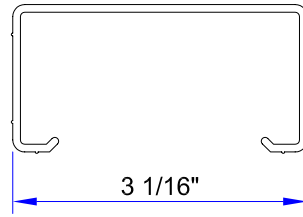

3 1/16" INSERT (ALCOA # 69966)
FOR 2 x 8, 2 x 10, 2 x 12 (# 69962, 69959, 69963)

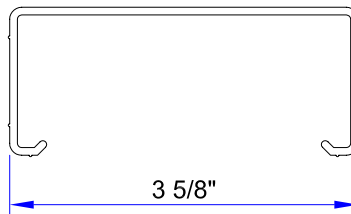

3 5/8" INSERT (ALCOA # 69801)
FOR ALL FOOT BOARDS IN THE CI, WD, GI, SERIES

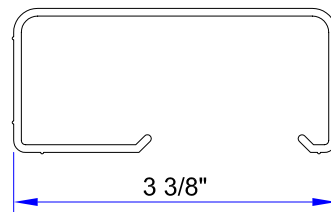

3 3/8" INSERT (ALCOA # 67049)
FOR 2 x 10 (# 60772)

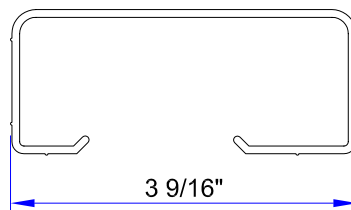

3 9/16" INSERT (ALCOA # 65520)
FOR 2 x 8 (# 65482)

ALUMINUM END CAPS AND CLIPS

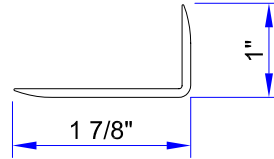

L-SHAPE END CAP (ALCOA # 69664)

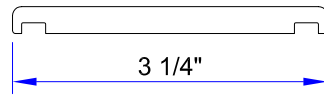

3 1/4" CLIP (ALCOA # 12852)

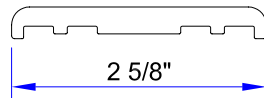

2 5/8" CLIP (ALCOA # 68517)

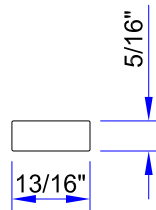

CHANNEL CLIP (ALCOA # 69984)

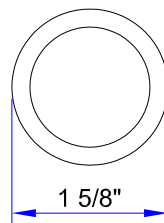

1 1/4" SCH. 40 PIPE, 1 5/8 O.D. (ALCOA # 6022)

ALUMINUM STANCHIONS

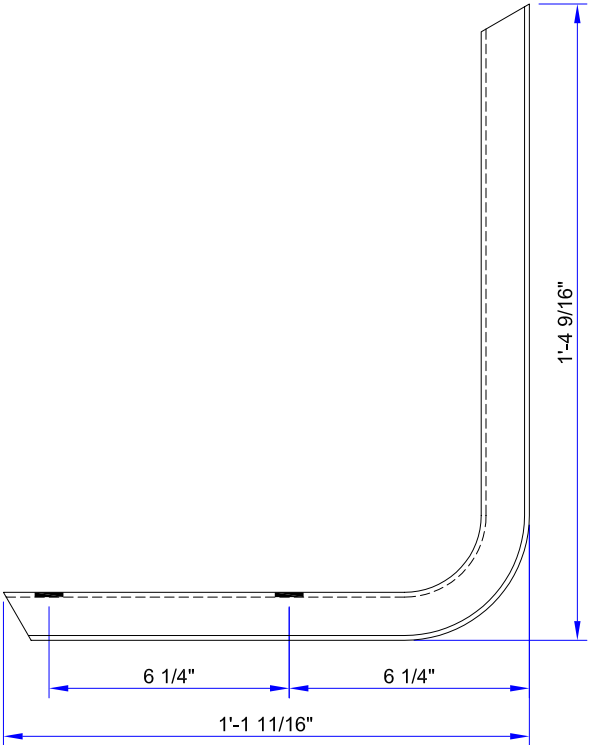

STANCHION (ALCOA # T-5609)

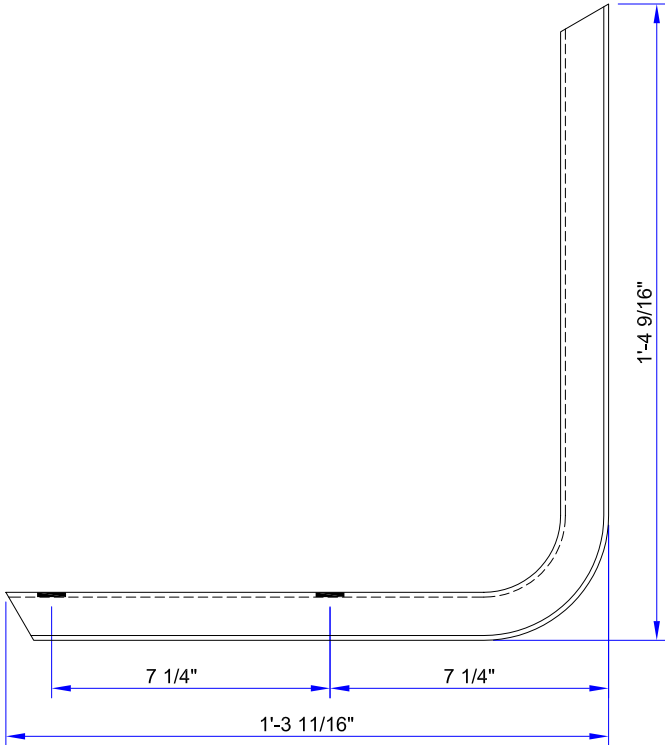

STANCHION (ALCOA # T-294)

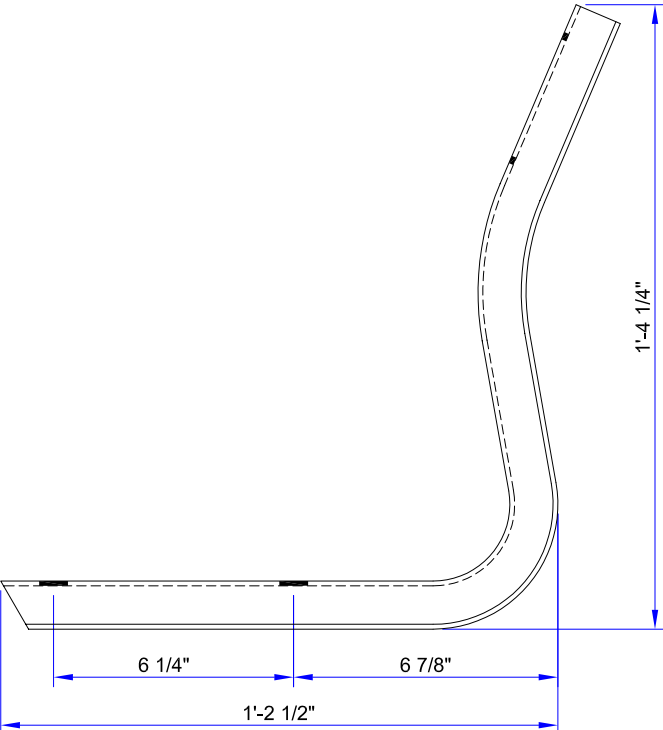

STANCHION (ALCOA # T-3200)

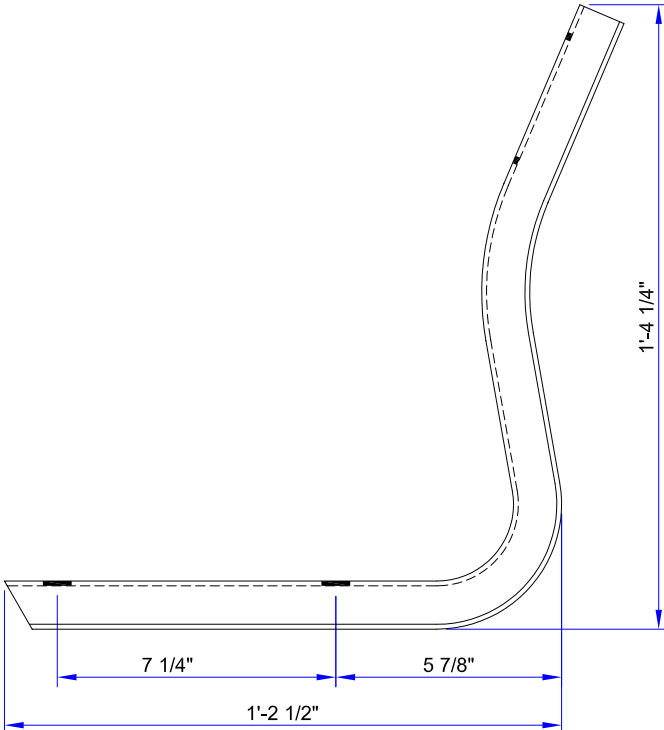

STANCHION (ALCOA # T-2402)

E & D ALUMINUM PLANKS AND RISERS DIE NUMBERS 2004

[FP] FULL PLANK SERIES (SEMI CLOSED SERIES)	ALCOA DIE #	INSERT	ALCOA DIE #	CLIP
2 x 12 SC-DECK	69963	3 1/16" INSERT	69966	2 5/8" CLIP
2 x 10 SC-DECK	69959	3 1/16" INSERT	69966	2 5/8" CLIP
2 x 8 SC-DECK	69962	3 1/16" INSERT	69966	2 5/8" CLIP
2 x 6	12214	N/A		2 5/8" CLIP
2 x 4	14993	N/A		2 5/8" CLIP
1 x 12 SC-RISER	70002	N/A		2 5/8" CLIP
1 x 10 SC-RISER	70004	N/A		2 5/8" CLIP
1 x 8 SC-RISER	70001	N/A		2 5/8" CLIP
1 x 6 SC-RISER	70003	N/A		2 5/8" CLIP
STAIR RISER	69733	N/A		
2 x 12 STEP BOARD	69972	3 1/16" INSERT	69966	2 5/8" CLIP
2 x 5 STEP NOSE	70014	3 1/16" INSERT	69966	2 5/8" CLIP
[CI] CHANNEL INTERLOCK SERIES				
2 x 9 CI-NOSE	69804	3 5/8" INSERT	69801	3 1/4" CLIP
2 x 7 CI-HEEL	69800	3 5/8" INSERT	69801	3 1/4" CLIP
1 x 12 CI-RISER	70035			
1 x 10 CI-RISER	69988	N/A		N/A
1 x 9 CI-RISER	69987	N/A		N/A
1 x 8 CI-RISER	69850	N/A		N/A
1 x 7 CI-RISER	70026			
1 x 6 CI-RISER	69974	N/A		N/A
1 x 5 CI-RISER	70052	N/A		N/A
1 x 4 CI-RISER	69973	N/A		N/A
[WD] WELDED DECK SERIES (INTERLOCKING DECK BDS.)				
2 x 12 IL-NOSE	69961	3 5/8" INSERT	69801	3 1/4" CLIP
2 x 12 IL-DECK	69960	3 5/8" INSERT	69801	3 1/4" CLIP
2 x 10 IL-DECK	69802	3 5/8" INSERT	69801	3 1/4" CLIP
2 x 9 IL-DECK	69964	3 5/8" INSERT	69801	3 1/4" CLIP
2 x 8 IL-DECK	69803	3 5/8" INSERT	69801	3 1/4" CLIP
2 x 5 IL-DECK	69965	3 5/8" INSERT	69801	3 1/4" CLIP
1 1/2 x 11 IL-RISER	68106	N/A		N/A
1 1/2 x 10 IL-RISER	68105	N/A		N/A
1 1/2 x 9 IL-RISER	68395	N/A		N/A
1 1/2 x 8 1/2 IL-RISER	69704	N/A		N/A
1 1/2 x 8 IL-RISER	68194	N/A		N/A
1 1/2 x 7 IL-RISER	68492	N/A		N/A
1 1/2 x 6 1/2 IL-RISER	69637	N/A		N/A
1 1/2 x 6 IL-RISER	68195	N/A		N/A
[GI] GUTTER INTERLOCK SERIES				
2 x 10 GI-NOSE	69942	3 5/8" INSERT	69801	3 1/4" CLIP
2 x 7 GI-HEEL	69943	3 5/8" INSERT	69801	3 1/4" CLIP
2 x 11 GI-DECK	69946	3 5/8" INSERT	69801	3 1/4" CLIP
2 x 10 GI-DECK	69970	3 5/8" INSERT	69801	3 1/4" CLIP
2 x 9 GI-DECK	69945	3 5/8" INSERT	69801	3 1/4" CLIP
2 x 7 GI-DECK	69944	3 5/8" INSERT	69801	3 1/4" CLIP
2 x 6 GI-DECK	69969	3 5/8" INSERT	69801	3 1/4" CLIP
SEAT PLANKS				
12" CONTOURED SEAT	11965	N/A		2 5/8" CLIP
10" CONTOURED SEAT	68754	N/A		2 5/8" CLIP
1 1/2 x 9 PERMA CAP	67817	N/A		2 5/8" CLIP
ALUMINUM REPLACEMENT				
2 x 10	60772	3 3/8" INSERT	67049	2 5/8" CLIP
2 x 8	65482	3 9/16" INSERT	65520	2 5/8" CLIP

CLOSURES, END CAP & MISCELLANEOUS DIE NUMBERS 2004

BACK RESTS

ALCOA DIE

CONTOURED DISH BACK	11161
CONTOURED SEAT BACK	11530

BACKREST STANCHIONS

CONTOURED DISH BACK FOR 2 x 10	T-3200
CONTOURED DISH BACK FOR 2 x 12	T-2402
CONTOURED SEAT BACK FOR 2 x 10	T-5609
CONTOURED SEAT BACK FOR 2 x 12	T-294

CLOSURES

5 1/2 x 3 3/4 CLOSURE	65987
1 1/2 x 1 1/2 CLOSURE	66782
EXPANSION JOINT COVER	66638

COLORED NOSING

1 1/4" COLORED NOSE (BLACK)	68566
1" COLORED NOSE (BLACK)	68024

END CAPS

L-SHAPE END CAP	69664	
12" CONTOURED SEAT END CAP (RIGHT)	15346-12R	
12" CONTOURED SEAT END CAP (LEFT)	15346-12L	
2 x 4 ALCOA END CAP	62390-4	
2 x 6 ALCOA END CAP	62390-6	
2 x 8 ALCOA END CAP	62390-8	
2 x 10 ALCOA END CAP	62390-10	USE E&D STAMPED END CAP
2 x 12 ALCOA END CAP	62390-12	
CONTOURED DISH BACKREST END CAP (RIGHT)	11165-R	
CONTOURED DISH BACKREST END CAP (LEFT)	11165-L	
CONTOURED BACKREST END CAP (RIGHT)	15345-R	
CONTOURED BACKREST END CAP (LEFT)	15345-L	
10" E&D STAMPED END CAP		
10" CONTOURED E&D STAMPED END CAP		

CLIP STOCK

3 1/4" CLIP	12852
2 5/8" CLIP	68517
CHANNEL CLIP	69984

PIPE

1 1/4 SCH. 40 PIPE (1 5/8" O.D.)	6022
----------------------------------	------

MAXIMUM ORDER LENGTHS FOR ALCOA

MILL FINISH = 36'-6"
ANODIZED = 32'-0" (in limited quantities 32'-6")
POWDER COATED = 24'-0" (in limited quantities 24'-6")